

ABS-Lock® X-Rivet

LX-SW-N-XXX



MoA 092-11



Werkzeuge | Tools



4,9 - 5,0



24



24

Sicherheitshinweise | Safety instructions



- DE** Die Anweisungen der Montageanleitung (1) und Sicherheitshinweise (2) sind strikt einzuhalten.
- EN** The information contained in the assembly instructions (1) and safety instructions (2) must be strictly observed.
- NL** De aanwijzingen in de montagehandleiding (1) en de veiligheidsvoorschriften (2) moeten strikt worden nageleefd.
- ES** Respete estrictamente las instrucciones del manual de montaje (1) y las indicaciones de seguridad (2).
- IT** È assolutamente necessario attenersi alle istruzioni di montaggio (1) e alle norme di sicurezza (2).
- FR** Les instructions de la notice de montage (1) et les consignes de sécurité (2) doivent être formellement respectées.
- PL** Należy ściśle przestrzegać instrukcji montażu (1) i wskazań bezpieczeństwa (2).
- DK** Montagevejledningens (1) anvisninger som også sikkerhedshenvisningerne (2) skal overholdes.
- CZ** Je nutné striktně dodržovat instrukce obsažené v montážním návodu (1) a v bezpečnostních pokynech (2).
- GR** Πρέπει να τηρούνται αυστηρά οι οδηγίες του χειριδίου συναρμολόγησης (1) και των υποδείξεων ασφαλείας (2).
- SK** Dôsledne dodržiavajte pokyny montážneho návodu (1) a bezpečnostné pokyny (2).
- TR** Montaj kılavuzunun (1) ve güvenliik uyarılarının talimatlarına (2) kesinlikle uyulmalıdır.
- NO** Det er svært viktig at instruksjonene i monteringshåndboken (1) og sikkerhetsheftet (2) følges.
- RUS** Необходимо строго соблюдать требования руководства по монтажу (1) и инструкции по безопасности (2).
- RO** Indicațiile din instrucțiunile de montare (1) și din broșura cu indicații de siguranță (2) trebuie respectate cu strictețe.
- FI** Asennusohjeen (1) ja turvaohjevhikosen (2) ohjeita on ehdottomasti noudatettava.
- SE** Anvisningarna till monteringsanvisningen (1) och säkerhetsmanualen (2) måste iakttas under alla omständigheter.
- HI** इंस्ट्रक्शन् के निर्देशों (1) और सुरक्षा निर्देश मैनुअल (2) में दिये गये निर्देशों का सख्ती से अनुसरण किया जाना चाहिए।
- ZH** 必须严格遵守装配说明书 (1) 和安全须知单 (2) 中的指示。
- SQ** Jëpb alntzram baltelimebt wawwde fi diltl tkwb (1) wktwb aršwawt almlame (2) bmttli dëqë.

Kontakte | Contact persons

Vertrieb & Technische Beratung

Sales & Technical Support

+49 (0) 28 32 - 972 81 - 0

vertrieb@absturzsiherung.de

Schulung

Training

+49 (0) 28 32 - 972 81 - 254

schulung@absturzsiherung.de

Montagevorbereitung

Assembly

+49 (0) 28 32 - 972 81 - 260



service@absturzsiherung.de

Mustertypenschild | Sample label

[ABS]

ABS SAFETY GMBH 3

Kevelaer, Germany
info@absturzsiherung.de
www.absturzsiherung.de

 1
 2

Mustertypenschild /
Sample only

Chargennummer /
Batch number

6 Normen / Standards

7 Max. Nutzer gleichzeitig (DIN EN 795:2012)

Max. No. of simultaneous users

11 Modellnummer / Model number

-

-

-

-

-

-



4

5

8

9

10



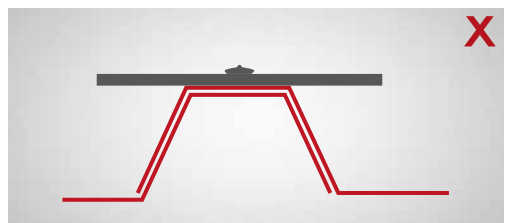
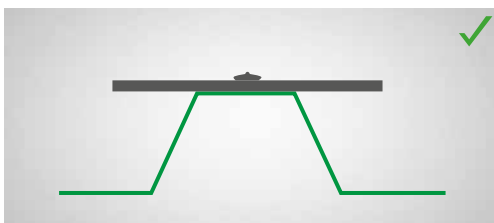
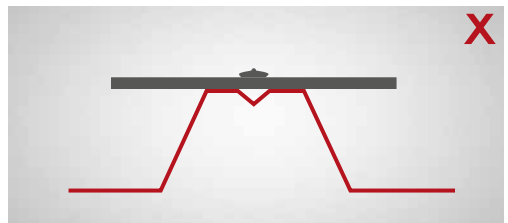
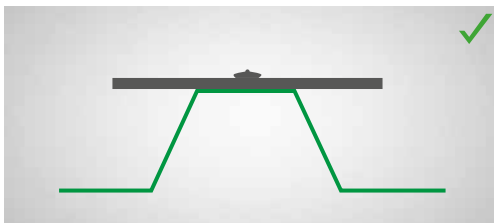
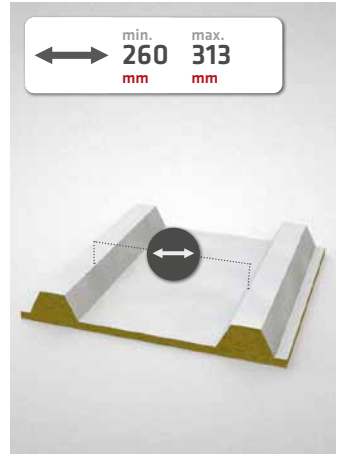
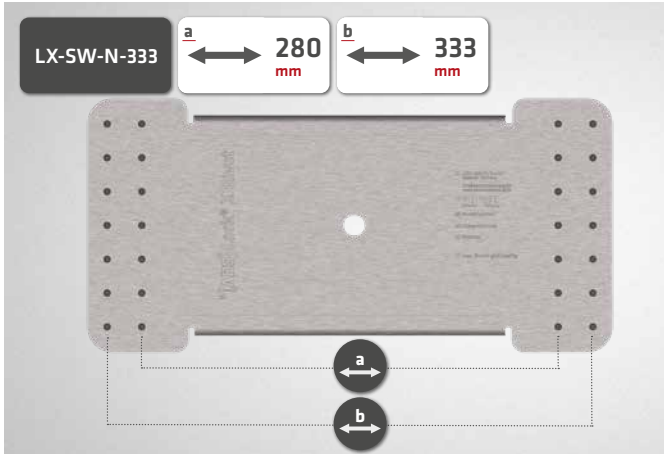
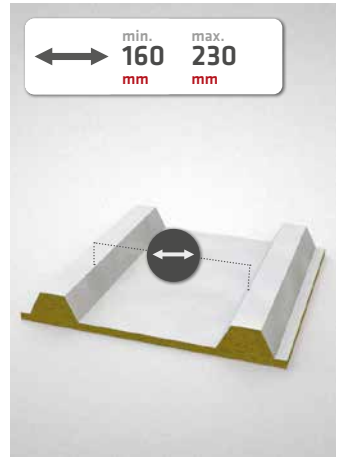
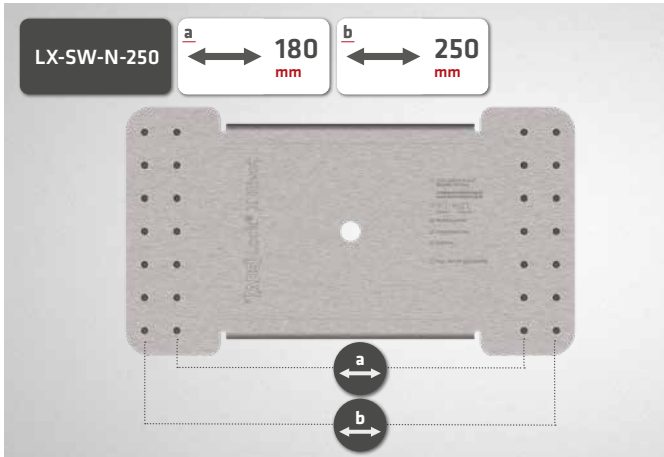

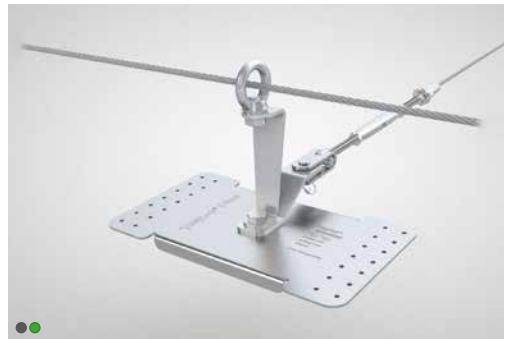
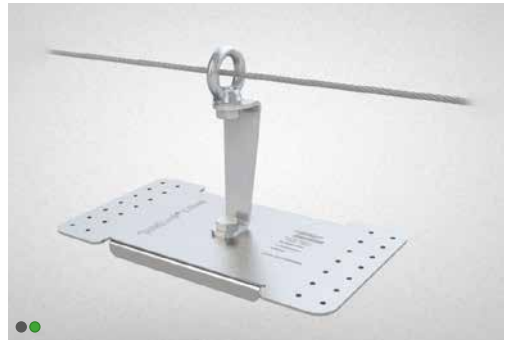

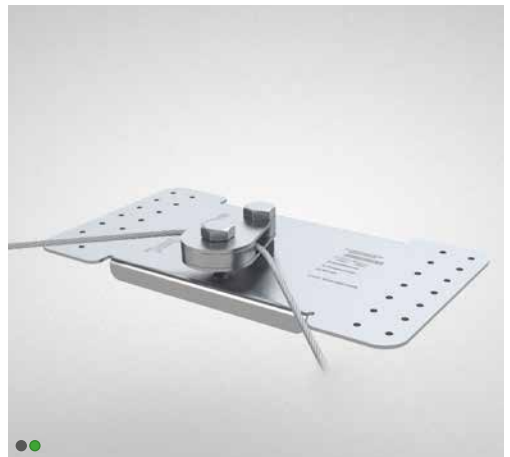
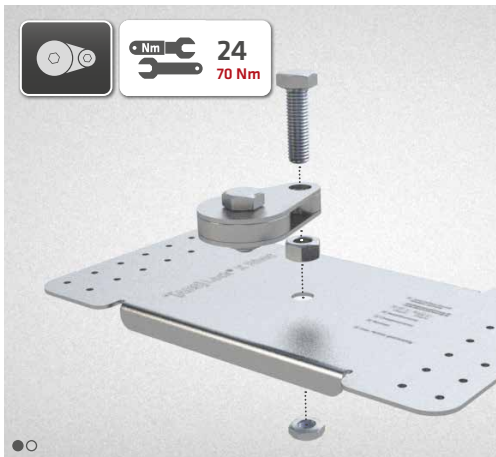
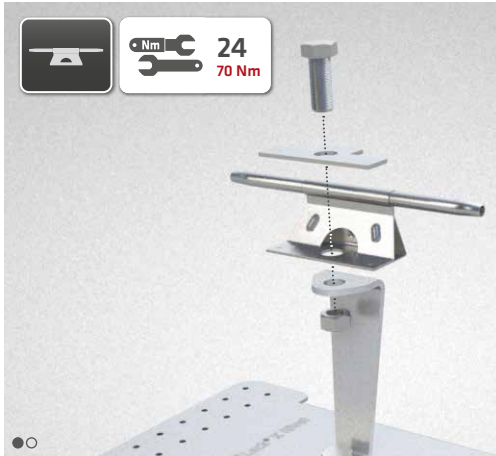
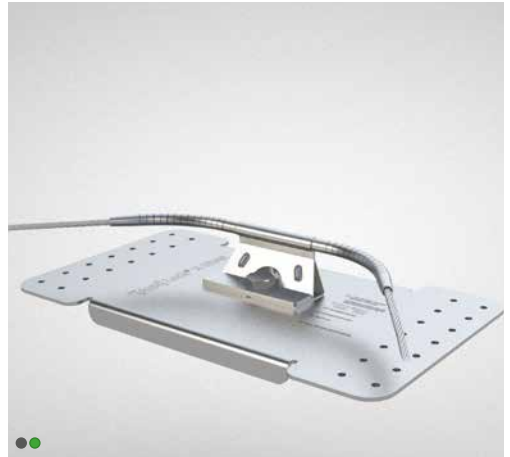

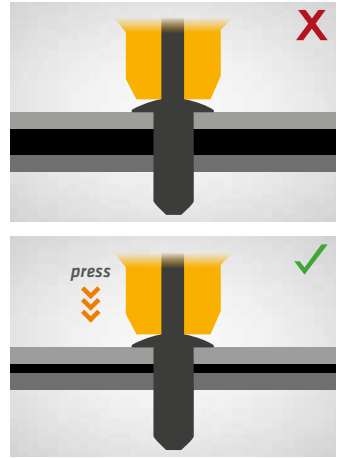
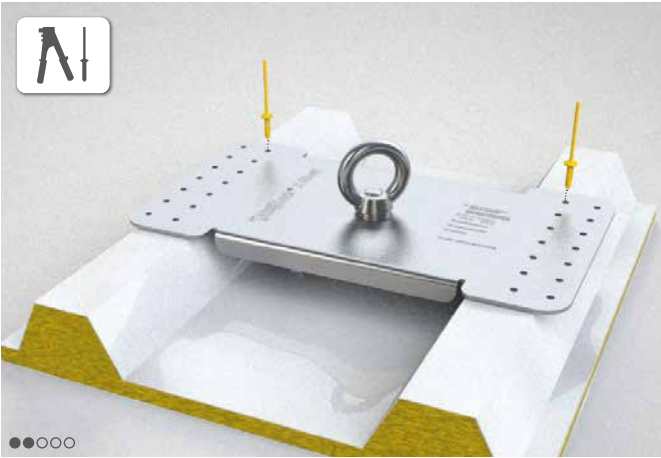
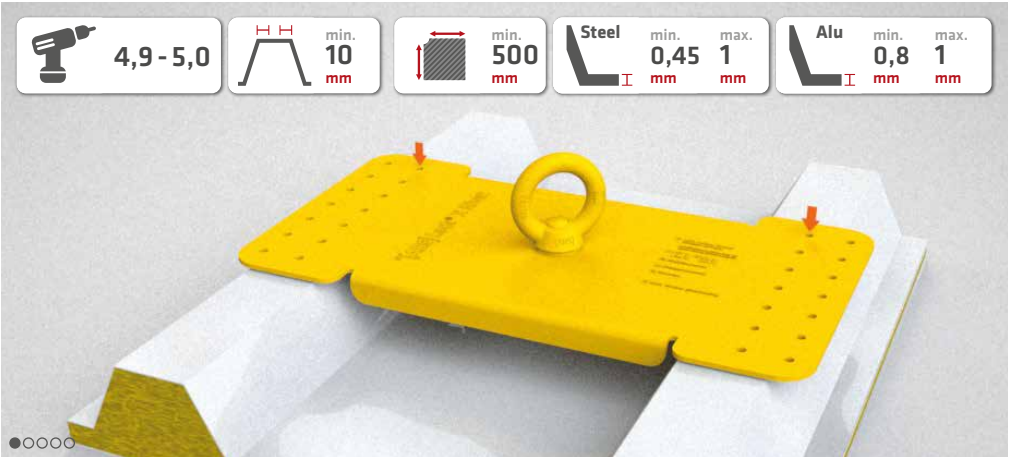

4,9 - 5,0

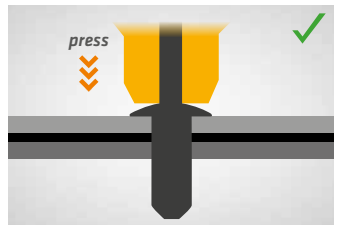
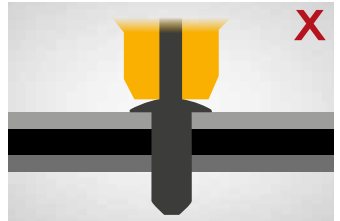
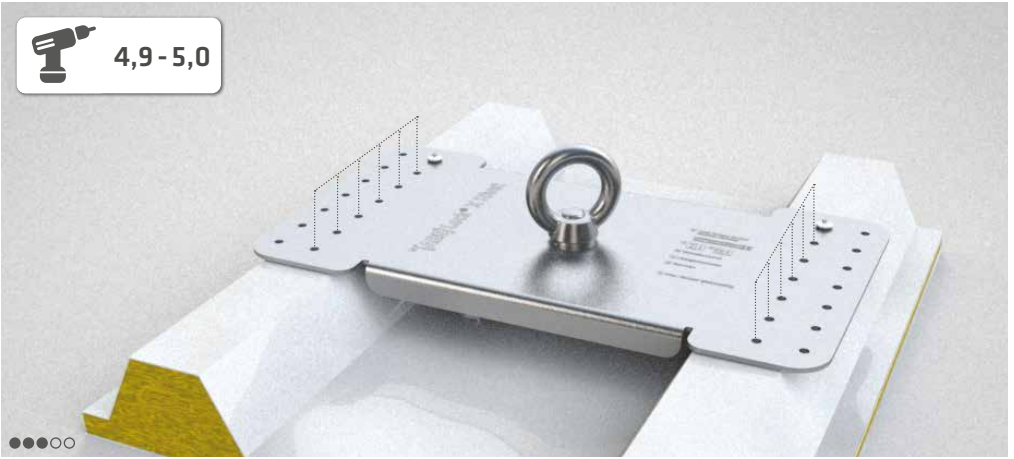

ALWAYS ON TOP!

ABS Safety GmbH

Gewerbering 3
D-47623 Kevelaer
Germany

Tel.: +49 (0) 28 32 - 972 81 - 0
Fax: +49 (0) 28 32 - 972 81 - 29

info@absturzsicherung.de

www.absturzsicherung.de
www.protection-anti-chute.fr
www.fall-arrest.eu

RS 77 Juli 2020



youtube.com/abssafetygmbh



facebook.com/ABS.Safety